

urmet

miro

Mod.
1750

DS 1750-008A

LBT 20057

VIDEOCITOFONO VIVAVOCE 2VOICE
2VOICE HAND-FREE VIDEO DOOR PHONE
VIDEOPHONE MAINS-LIBRES 2VOICE
VIDEOINTERFONO MANOS LIBRES 2VOICE
VIDEO-FREISPRECHANLAGE 2VOICE

Sch./Ref. 1750/5 (Nero, *Black*, Noire, Negro, Schwarz)

Sch./Ref. 1750/6 (Bianco, *White*, Blanc, Blanco, Weiß)

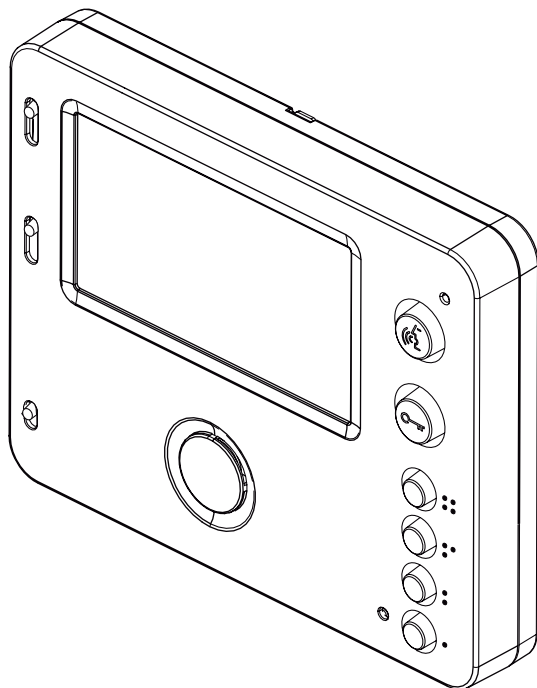

ITALIANO

I videocitofoni **miro** Sch. 1750/5 e 1750/6 sono dedicati all'utilizzo in impianti videocitofonici del sistema 2Voice.

DESCRIZIONE DEI COMPONENTI E CARATTERISTICHE

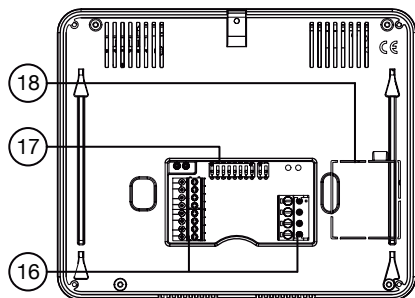
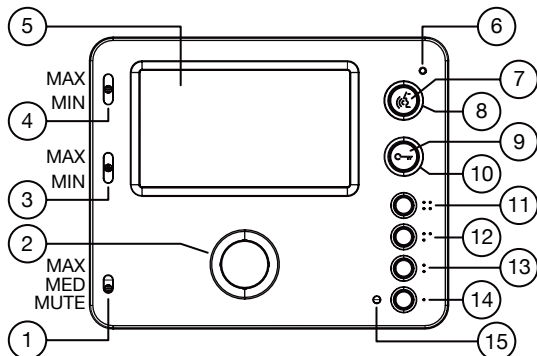

1. Regolazione volume di chiamata (MAX, MEDIO, MUTE)
2. Altoparlante di chiamata e conversazione
3. Regolazione luminosità display
4. Regolazione intensità colore display
5. Display 4,3" formato 16:9
6. Microfono
7. Pulsante attivazione/disattivazione fonia
8. Led verde presente sotto al pulsante
9. Pulsante apriporta
10. Led verde presente sotto al pulsante
11. Pulsante per connessione a dispositivi Yokis (contatti Y1, Y2): max 50 mA @ 24 Vcc
12. Pulsante per connessione a dispositivi Yokis (contatti X1, X2): max 50 mA @ 24 Vcc
13. Pulsante : vedi tabella funzione pulsanti
14. Pulsante : vedi tabella funzione pulsanti
15. Led di segnalazione multicolore
16. Morsetti per il collegamento al sistema
17. Dip-switch di configurazione:
 - n.1 di SW1, definisce la modalità di funzionamento del videocitofono: OFF "Mani libere" (default)/ ON " Push to talk";
 - n.2÷8 di SW1, definiscono il numero dell'appartamento nella colonna;
 - n.1÷2 di SW2, definiscono il numero del posto interno all'interno dell'appartamento.

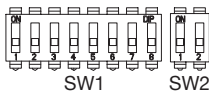

Per le impostazioni dei dip-switch fare riferimento al libretto di sistema.

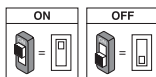

18. Sportellino da rimuovere nel caso di collegamento entra-esci con accessorio Sch. 1750/50

Il videocitofono **miro** è dotato di dispositivo per audiolesi integrato, funzionante solo durante le chiamate videocitofoniche.

INSTALLAZIONE

Murare la scatola incasso all'altezza indicata nel disegno seguente.
Fissare la staffa alla scatola incasso o a muro come indicato.
Programmare i dip-switch di programmazione.

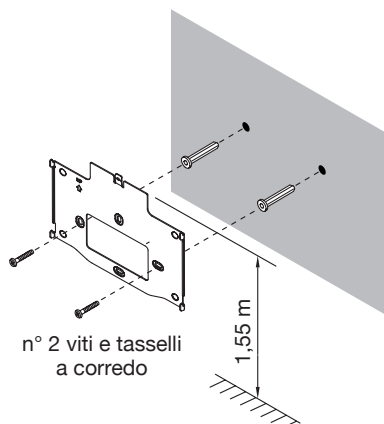
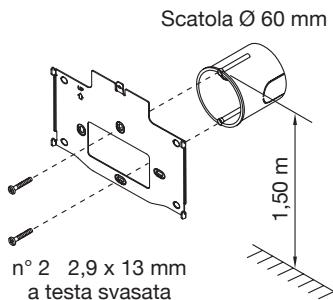
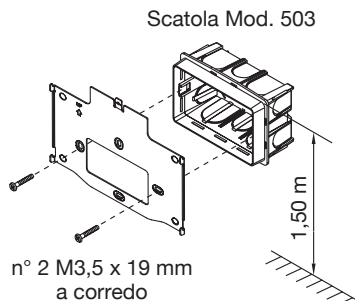

Eseguire i collegamenti.
Fissare il videocitofono alla staffa.

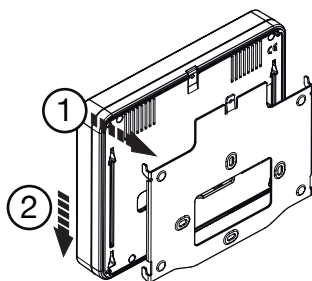

 Per rimuovere il videocitofono dalla staffa, inserire la punta di un cacciavite nella sede come indicato in figura e spingere il videocitofono verso l'alto.

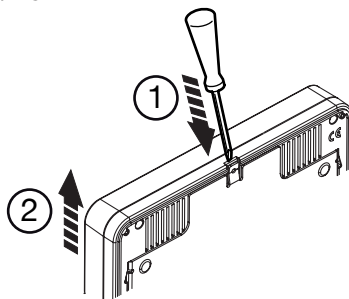

Per il collegamento del videocitofono in entra-esci bisogna rimuovere lo sportellino, come indicato in figura, ed inserire nella sede il circuito adattatore sch. 1750/50 seguendo le istruzioni riportate nel suo libretto a corredo prodotto.

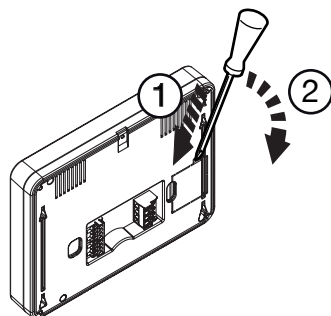



DESCRIZIONE DEI MORSETTI

- ⊘ S+ } Suoneria supplementare
- ⊘ S- }
- ⊘ X2 } Pulsante ●●
- ⊘ X1 }
- ⊘ Y2 } Pulsante ●●
- ⊘ Y1 }



- ⊘] CP Chiamata al piano
- ⊘] LINE IN Connessione al BUS di sistema

FUNZIONE PULSANTI

Stato Pulsante	RIPOSO	ATTESA SGANCIO (ricezione chiamata)	IN FONIA	RIPOSO E TASTO  PREMUTO	STATO DI PROGRAMMAZIONE* (SOLO CON VIDEOCITOFONO A RIPOSO)
	Apriporta pedonale	Apriporta pedonale	Apriporta pedonale	Apriporta pedonale	Abilita/disabilita apriporta automatico
	---	Attivazione della fonia	Se premuto nella modalità di funzionamento: A) "Mani libere" termina la conversazione; B) in "Push to talk": — se premuto a lungo abilita la fonia verso il posto esterno; — se premuto brevemente attiva o termina la conversazione.	---	---
●●	Autoinserzione	Palleggiamento video	Funzione speciale (default: 8)	Chiamata intercomunicante 2 programmabile (default: non programmato)	Scelta suoneria chiamata al piano (5 suonerie diverse)
●	Apriporta passo carraio	Apriporta passo carraio	Apriporta passo carraio	Chiamata intercomunicante 1 programmabile (default: chiamata a centralino)	Scelta suoneria chiamata citofonica (5 suonerie diverse)

(*) Per entrare o uscire dallo stato di programmazione premere e tenere premuto il tasto ● per più di 5 secondi; la conferma dell'entrata in programmazione avviene con il lampeggio lento del led giallo; comunque allo scadere della temporizzazione di 10 min si esce dallo stato di programmazione.

SEGNALAZIONI LED

8. Led verde presente sotto al pulsante 
acceso fisso: chiamata in corso
acceso lampeggiante: conversazione in corso
10. Led verde presente sotto al pulsante 
acceso fisso: possibilità di apertura porta
15. Led di segnalazione multicolore

PRIORITÀ	FUNZIONI
1	Verde lampeggiante: apriporta automatico attivo
2	Rosso acceso fisso: porta aperta sul posto di chiamata principale
3	Rosso lampeggiante lento: porta aperta sul posto di chiamata secondario
4	Giallo lampeggiante lento: stato di programmazione attivo

 Per salvare la programmazione ricordarsi di uscire dalla stessa tenendo premuto il tasto ● per più di 5 secondi; comunque trascorsi 10 minuti il dispositivo esce dallo stato di programmazione salvando i parametri variati.

Per la programmazione della chiamata intercomunicante fare riferimento al libretto di sistema.

RESET

Per ripristinare i parametri di default del dispositivo, dopo l'ingresso in programmazione con la pressione del tasto ● per più di 5 secondi, premere contemporaneamente i tasti ● e  per più di 3 secondi; la conferma del comando avviene con l'emissione di 2 beep lunghi e l'uscita del dispositivo dallo stato di programmazione.

FUNZIONAMENTO CON PROTESI ACUSTICA

Il videocitofono è dotato di un dispositivo che consente alle persone udipoles, dotate di apposito auricolare, di poter sentire chi sta parlando dalla postazione di chiamata o da altri videocitofoni in caso di chiamate da centralino. Il dispositivo è in grado di interfacciarsi con apparecchi acustici per audipoles con funzione "T" posti ad una distanza di circa 20 cm.

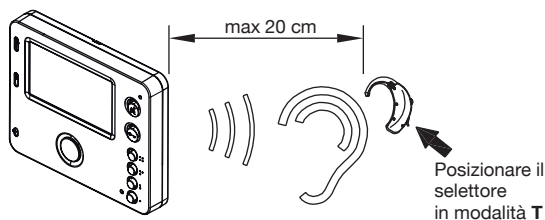

MUTE ALTOPARLANTE SUONERIA



È possibile regolare il volume di chiamata fino ad escludere la suoneria (Mute) agendo sul cursore a slitta 1 (vedere § Descrizione dei componenti e caratteristiche).

Lo stato di mute è evidenziato da un'indicazione di colore rosso visibile nella parte alta del cursore.

 **Se il cursore è nella posizione MUTE, in caso di chiamata il modulo video del videocitofono si accenderà se la chiamata è video; inoltre anche tutte le segnalazioni acustiche (beep) saranno disabilitate. Non saranno invece escluse le eventuali suonerie supplementari.**

ATTIVAZIONE FONIA CON PRESSIONE DEL TASTO (MODALITÀ PUSH TO TALK)

Se la comunicazione tra la postazione di chiamata e il videocitofono risulta disturbata è possibile attivare i due canali di fonia (verso l'interno e verso l'esterno) singolarmente.

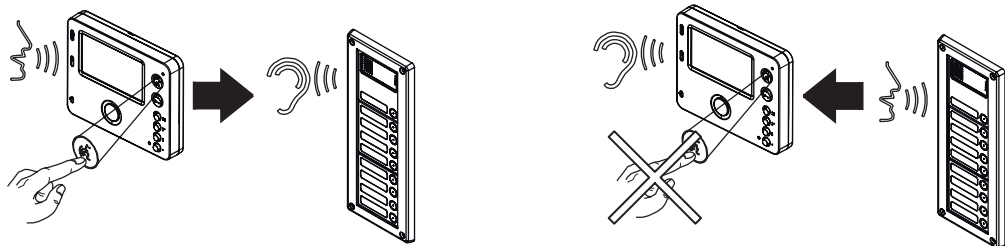

Dopo aver ricevuto una chiamata, premere brevemente per attivare la fonia dal posto esterno, in seguito se viene mantenuto premuto il tasto  si attiva il canale audio verso l'esterno e si può parlare al chiamante. Per ascoltare occorre rilasciare il tasto .

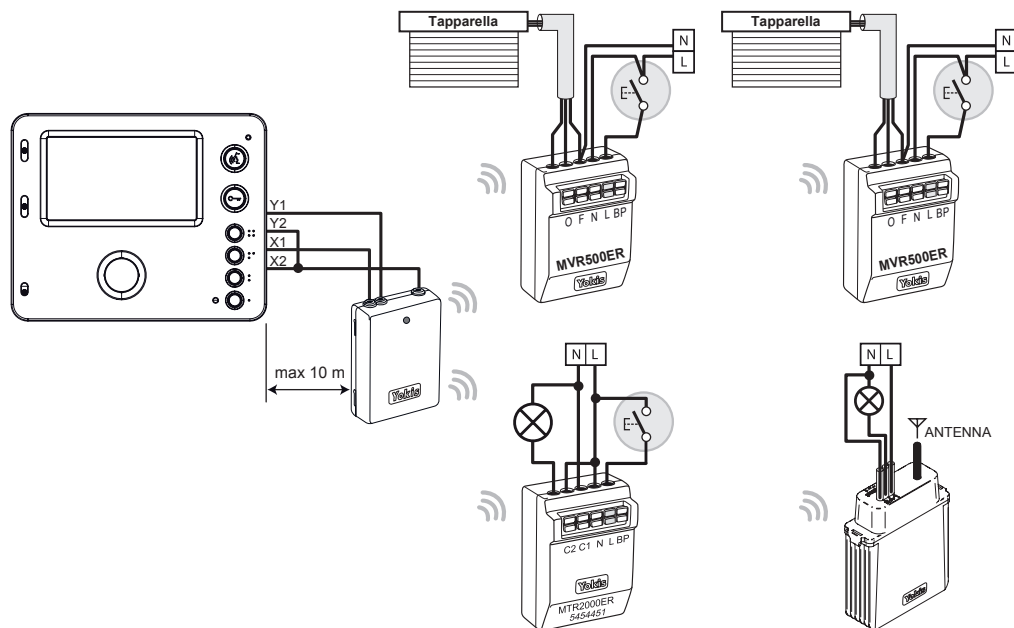

Per terminare la conversazione premere brevemente il tasto .

Collegamento al videocitofono mirò di un modulo E2BP per la centralizzazione di luci e tapparella



-  A seguito di opportuna programmazione dei dispositivi Yokis si potrà:
- con un pulsante ad es.  attivare la chiusura centralizzata delle tapparelle;
 - con un secondo pulsante (ad es. ) attivare lo spegnimento delle luci.







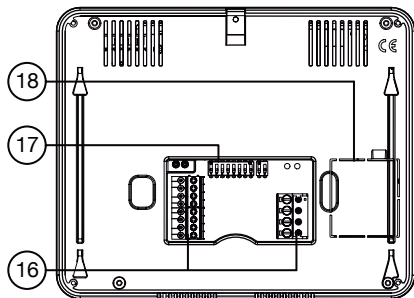
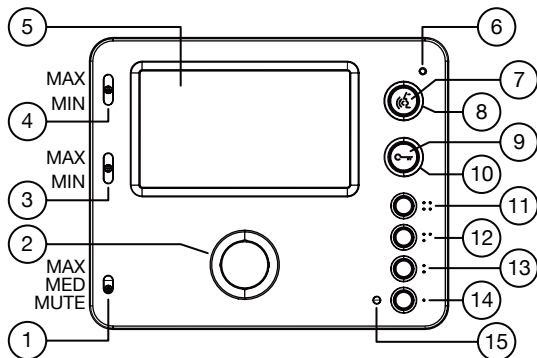

Per maggiori informazioni sui prodotti YOKIS andare sul sito www.yokis.com

ENGLISH

The **miro** video door phone Sch. 1750/5 and 1750/6 are dedicated to be used in 2Voice video door phone systems.

DESCRIPTION OF COMPONENTS AND FEATURES



1. Call volume adjustment (MAX, MEDIUM; MUTE)
2. Call and conversation speaker
3. Display brightness adjustment
4. Display colour intensity adjustment
5. Display 4.3" format 16:9
6. Microphone
7. Button  used to activate/deactivate audio
8. Green LED under the  button
9.  door opener button
10. Green LED under the  button
11.  Button to connect to Yokis devices; contacts Y1, Y2: max 50 mA @ 24 Vcc
12.  Button to connect to Yokis devices; contacts X1, X2: max 50 mA @ 24 Vcc
13. Button  : see button function table
14. Button  : see button function table
15. Multicolour indicator LED
16. Terminals for connecting to the system
17. Configuration dip switch:
 - n.1 of SW1, defines the video door phone operating mode: OFF "Hands Free" (default) / ON "Push to talk"
 - n.2÷8 of SW1, define the apartment number in the column;
 - n.1÷2 of SW2, define the station number in the apartment.



 Refer to the system booklet for how to set the dip switches.

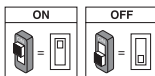

18. Door to be removed in case of in-out connection with Ref. accessory 1750/50

 The **miro** video door phone is equipped with a built in hearing aid device that works only during the video door phone calls.

INSTALLATION

Install flush-mounting box at the height indicated in the drawing below.
Fix the bracket to the mounting box or to the wall as indicated.
Program the dip switches.

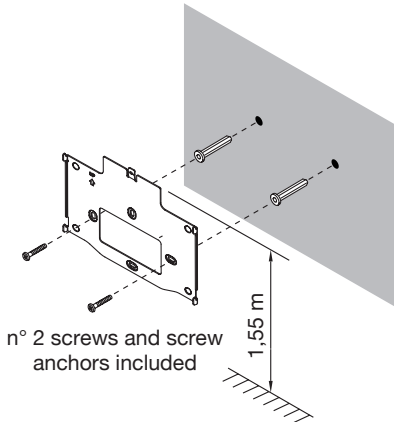
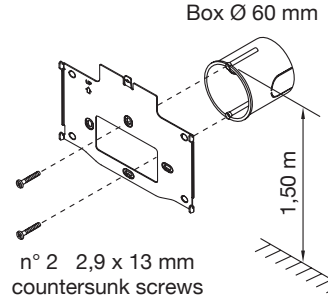
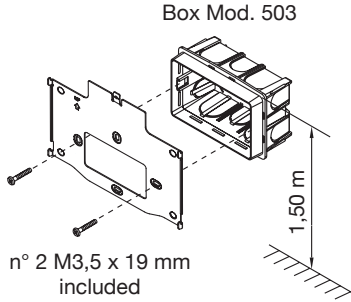

Connect.
Fix the video door phone to the bracket.

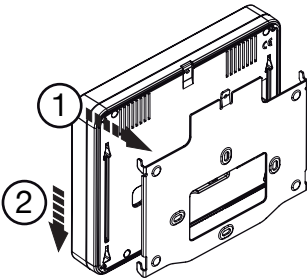

 To remove the video door phone from the bracket, insert the tip of a screwdriver into the seating as indicated in the figure and push the video door phone upwards.

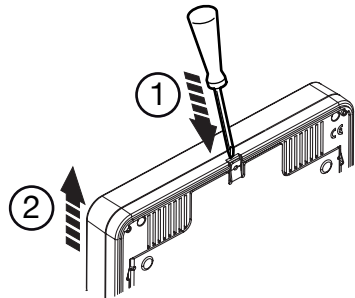

To connect the video door phone in in-out, it is necessary to remove the door, as indicated in the figure, and insert the adaptor circuit Ref. 1750/50, following the instructions found in the booklet provided with the product.

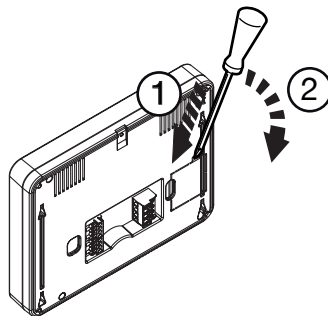

TERMINAL PINS DESCRIPTION



- S+ } Supplementary ringer
- S- }
- X2 } Button ●●
- X1 }
- Y2 } Button ●●
- Y1 }
-] CP Floor call
-] LINE IN System bus connection
-]

BUTTON FUNCTIONS

State Button	STAND-BY	WAITING FOR PICK-UP (RECEIVING CALL)	DURING AUDIO OPERATION	STAND-BY AND BUTTON PRESSED	STATE OF PROGRAMMING* (ONLY WITH VIDEO DOOR PHONE IN STAND-BY)
	Open pedestrian door	Open pedestrian door	Open pedestrian door	Open pedestrian door	Connect / disconnect the automatic door opening system
	---	Audio activation	If pressed in the operating mode: A) "Hands Free" ends the conversation; B) in "Push to talk": — if pressed a long time, it enables the audio of the door unit; — if short pressed it activates or terminates the conversation.	---	---
●●	Auto-on function	Video switching	Special function (default: 8)	Programmable intercom call 2 (Default: not programmed)	Floor call ring tone selection (5 different ring tones)
●	Garage door opener	Garage door opener	Garage door opener	Programmable intercom call 1 (Default: call to switchboard)	Door phone call ring tone (5 different ring tones)

(*) To enter and exit programming state, hold button ● pressed for longer than 5 seconds. The yellow LED will blink slowly to indicate that programming mode is selected. Programming mode will shut down in all cases after the 10 minute timeout.

INDICATOR LEDS

8. Green LED under the  button
On steady: call in progress
On blinking: conversation ongoing
10. Green LED under the  button
On steady: possibility of a door opening
15. Multicolour indicator LED

PRIORITY	FUNCTIONS
1	Green blinking: automatic door opener active
2	Red on steady: main calling station door open
3	Slowly blinking red: secondary calling station door open
4	Slowly blinking yellow: programming state on

 *To save the programming, remember to exit from the same by pressing the ● button for more than 5 seconds; in any case, after 10 minutes the device exits the programming state and saves the parameters changed. Refer to the system booklet for how to program intercom calls.*

RESET

To restore default parameters of the device after entering programming mode, hold button ● pressed for longer than 5 seconds, press the ● and  buttons together for longer than 3 seconds. The system will emit 2 long beeps to confirm and exit the programming state.

OPERATION WITH A HEARING AID

The video door phone is equipped with a device that enables the hearing impaired with a hearing aid to be able to hear the person talking from the calling station or from other video door phones in case of calls from the switchboard. The device is capable of interfacing with hearing aids with “T” function at a distance of about 20 cm.

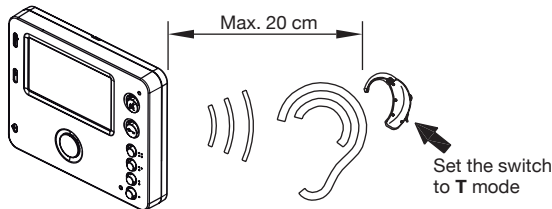

MUTE RING-TONE SPEAKER



It is possible to adjust the call volume to the point of excluding the ring tone (Mute) by moving the sliding cursor (see § Description of components and features).

The mute state is indicated by a red signal visible in the upper part of the cursor.

 ***If the cursor is in the MUTE position, in case of a call the video door phone video module will turn on if it is a video call; moreover, all the acoustic signals (beeps) will be disabled. Supplementary ring-tone events will not be excluded.***

ACTIVATING AUDIO BY PRESSING THE (PUSH TO TALK MODE) BUTTON

If the communication between the calling station and the video door phone is disturbed, it is possible to activate the two audio channels (inwards and outwards) individually.

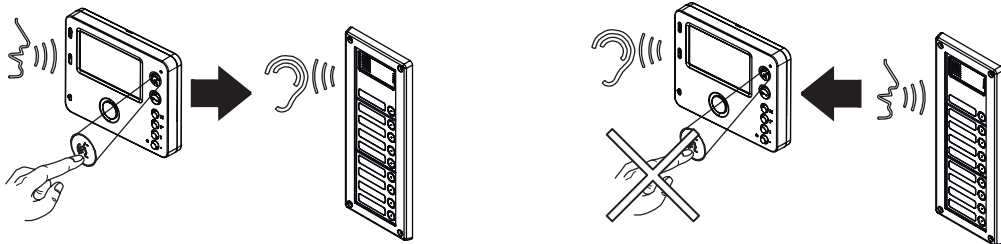

After having received a call, short press to activate the audio from the door unit, then if the  button is **held pressed down**, the audio channel is activated externally and the user can speak to the caller. To listen, it is necessary to press the  button.

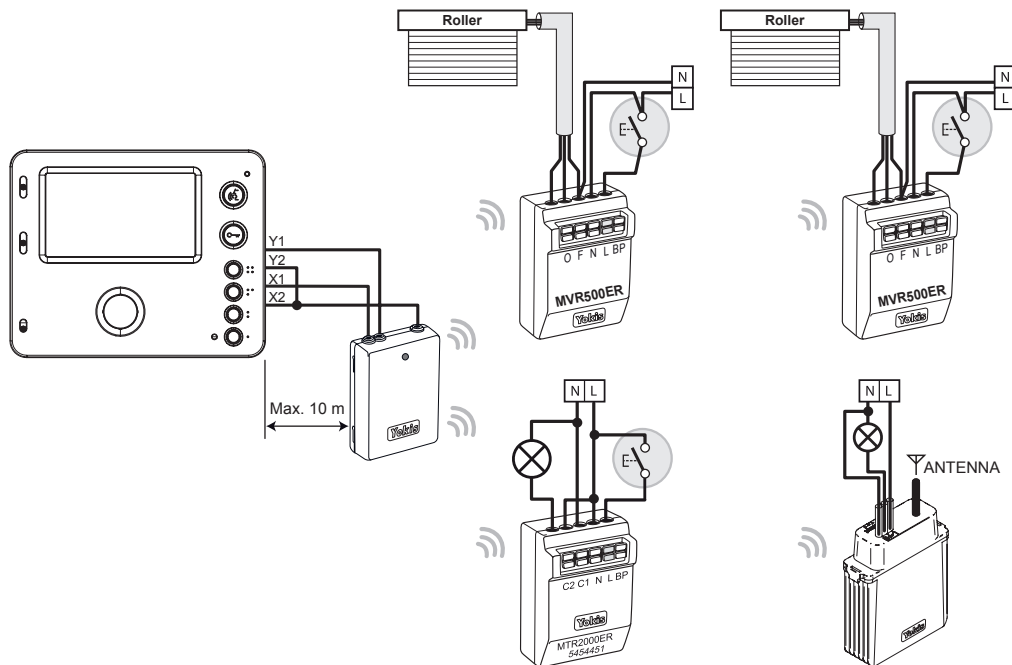

To end the conversation, **shortly press**  button.

Connection of a E2BP module to the mIR0 video door phone for the centralisation of lights and rollers



-  After suitably programming the YOKIS devices, it will be possible:
- to activate the centralised closing of the rollers with a button (for example: );
 - a second button (for example: ) will activate the turning off of the lights.

For more information on YOKIS products, please visit www.yokis.com

FRANÇAIS

Les vidéophones **miro** Réf. 1750/5 et 1750/6 sont conçus pour être utilisés dans les installations de vidéophonie du système 2Voice.

DESCRIPTION DES COMPOSANTS ET CARACTERISTIQUES

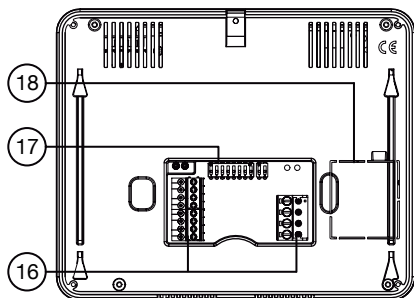
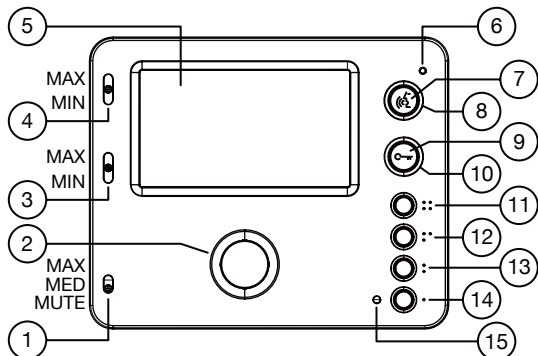

1. Réglage du volume d'appel (MAXI, MOYEN, MUTE)
2. Haut-parleur d'appel et de conversation
3. Réglage de la luminosité de l'afficheur
4. Réglage d'intensité de la couleur de l'afficheur
5. Afficheur 4,3", format 16:9
6. Microphone
7. Touche d'activation/désactivation phonie
8. LED verte située au-dessous de la touche
9. Touche ouvre-porte
10. LED verte située au-dessous de la touche
11. Touche pour la connexion à des dispositifs Yokis; contacts Y1, Y2: maxi 50 mA à 24 Vcc
12. Touche pour la connexion à des dispositifs Yokis; contacts X1, X2: maxi 50 mA à 24 Vcc
13. Touche : voir le tableau des fonctions des touches
14. Touche : voir le tableau des fonctions des touches
15. LED de signalisation multicolore
16. Bornes de connexion au système
17. Commutateurs de configuration:
 - n.1 de SW1, définit le mode de fonctionnement du vidéophone: OFF "Mains-libres" (par défaut)/ ON " Push to talk";
 - n.2÷8 de SW1, définissent le numéro d'appartement dans la colonne;
 - n.1÷2 de SW2, définissent le numéro du poste interne dans l'appartement.

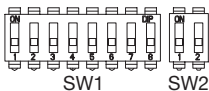

Pour les réglages des commutateurs, se reporter à la notice de système.

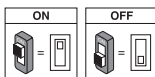

18. Volet à déposer en cas de raccordement entrée/sortie avec l'accessoire Réf. 1750/50

Le vidéophone **miro** est pourvu d'un dispositif pour les malentendants, qui fonctionne uniquement lors des appels par vidéophone.

INSTALLATION

Emmurer le boîtier encastrable à la hauteur indiquée dans la figure suivante.
Fixer l'étrier au boîtier encastrable ou à la paroi, comme indiqué.
Régler les commutateurs de programmation.

Boîtier Mod. 503

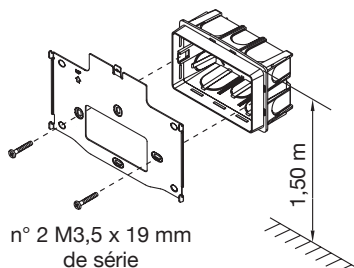

Boîtier Ø 60 mm

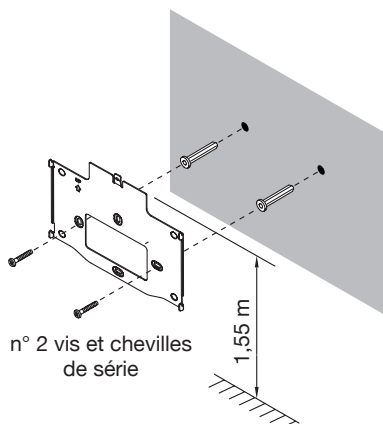
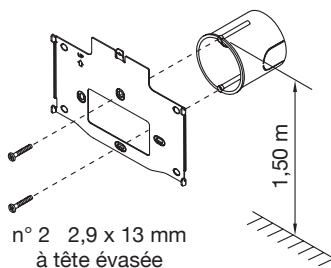

Réaliser les branchements.
Fixer le vidéophone à l'étrier.

 Pour déposer le vidéophone de l'étrier, introduire la pointe d'un tournevis dans le logement (voir figure) et pousser le vidéophone vers le haut.

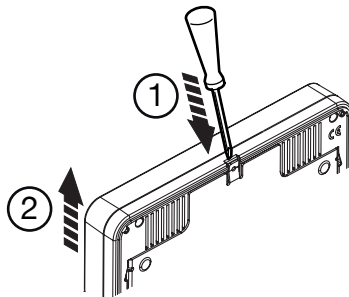
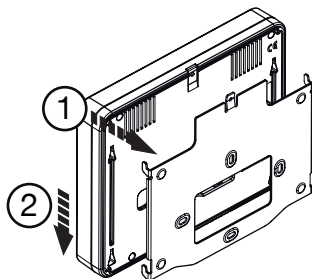

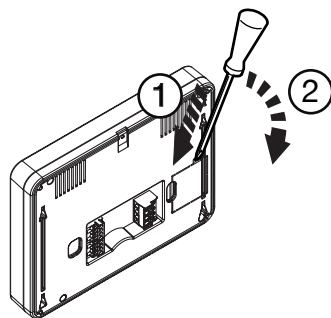

Pour le raccordement du vidéophone en mode entrée/sortie, il est nécessaire de déposer le volet (voir figure) et de mettre en place le circuit adaptateur Réf. 1750/50, en suivant les instructions contenues dans la notice du produit.



DESCRIPTION DES BORNES



- S+ } Sonnerie supplémentaire
- S- }
- X2 } Touche ●●
- X1 }
- Y2 } Touche ●●
- Y1 }
-] CP Appel à l'étage
-] LINE IN Connexion au BUS de système

FONCTIONS DES TOUCHES

Etat Touche	REPOS	ATTENTE DECROCHAGE (RECEPTION APPEL)	PHONIE	REPOS ET TOUCHE  ENFONCEE	ETAT DE PROGRAMMATION* (UNIQUEMENT SI VIDEOPHONE AU REPOS)
	Ouvre-porte piétons	Ouvre-porte piétons	Ouvre-porte piétons	Ouvre-porte piétons	Habilitation/exclusion ouvre-porte automatique
	---	Activation de la phonie	Si enfoncé en mode de fonctionnement: A) "Mains-libres" met fin à la conversation; B) dans "Push to talk": — si enfoncé de manière prolongée, habilite la phonie vers le poste externe; — si enfoncé brièvement, active ou met fin à la conversation.	---	---
●●	Activation automatique	Renvoi vidéo	Fonction spéciale (par défaut: 8)	Appel intercom 2 programmable (par défaut: non programmé)	Sélection sonnerie d'appel à l'étage (5 sonneries différentes)
●	Ouverture passage pour véhicules	Ouverture passage pour véhicules	Ouverture passage pour véhicules	Appel intercom 1 programmable (par défaut: appel vers centrale)	Sélection sonnerie d'appel d'interphone (5 sonneries différentes)

(*) Pour accéder ou quitter l'état de programmation, maintenir la touche ● enfoncée pendant plus de 5 secondes; le clignotement lent de la LED jaune confirme l'accès à la programmation. Au bout de 10 minutes, le système quittera automatiquement l'état de programmation.

SIGNALISATIONS PAR LED

8. LED verte située au-dessous de la touche 
lumière fixe: appel en cours
clignotement: conversation en cours
10. LED verte située au-dessous de la touche 
lumière fixe: possibilité d'ouverture porte
15. LED de signalisation multicolore

PRIORITE	FONCTIONS
1	Verte, clignotante: ouvre-porte automatique actif
2	Rouge, fixe: porte ouverte sur poste d'appel principal
3	Rouge, clignotement lent: porte ouverte sur poste d'appel secondaire
4	Jaune, clignotement lent: état de programmation actif

 Pour enregistrer la programmation, ne pas oublier de quitter ce mode en maintenant la touche ● enfoncée pendant plus de 5 secondes; au bout de 10 minutes, le dispositif quitte en tout cas l'état de programmation, en enregistrant les paramètres modifiés. Pour la programmation de l'appel intercom, se reporter à la notice de système.

RESET

Pour rétablir les paramètres par défaut du dispositif, après l'accès à la programmation en maintenant la touche ● enfoncée pendant plus de 5 secondes, appuyer en même temps sur les touches ● et  pendant plus de 3 secondes; la commande sera confirmée par l'émission de 2 bips sonores prolongés et par la sortie du dispositif de l'état de programmation.

FONCTIONNEMENT AVEC PROTHESE AUDITIVE

Le vidéophone est doté d'un dispositif permettant aux malentendants, pourvus d'un appareil auditif spécifique, d'entendre leur interlocuteur depuis le poste d'appel ou d'autres vidéophones en cas d'appels en provenance de la centrale. Ce dispositif est en mesure de s'interfacer avec des appareils auditifs avec fonction "T", situés à une distance d'environ 20 cm.

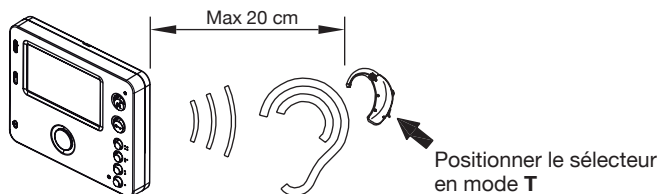



FONCTION MUTE DU HAUT-PARLEUR DE SONNERIE

Il est possible de régler le volume d'appel, jusqu'à exclure la sonnerie (Mute), en agissant sur le curseur à glissière 1 (voir § Description des composants et caractéristiques).
L'état Mute est mis en évidence par une indication rouge vif, en haut du curseur.

 Si le curseur est en position MUTE, le module vidéo du vidéophone s'allumera en cas d'appel vidéo et tous les signaux sonores (bips) seront désactivés. En revanche, les éventuelles sonneries supplémentaires ne seront pas exclues.

ACTIVATION DE LA PHONIE EN APPUYANT SUR LA TOUCHE (MODE PUSH TO TALK)

Si la communication entre le poste d'appel et le vidéophone est perturbée, il est possible d'activer individuellement les deux canaux de phonie (vers l'intérieur et vers l'extérieur).

Après avoir reçu un appel, appuyer brièvement pour activer la phonie depuis le poste externe; ensuite, si la touche  est maintenue enfoncée, le canal audio vers l'extérieur sera activé et la communication avec l'appelant pourra être établie. Pour écouter, il est nécessaire de relâcher la touche .

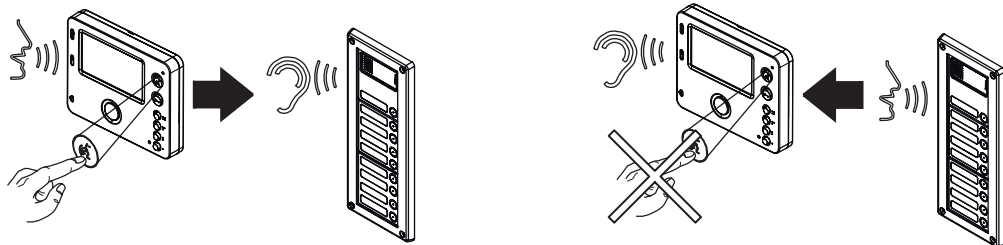

Pour terminer la communication, appuyer brièvement sur la touche .

Raccordement d'un module E2BP pour la centralisation de l'éclairage et des volets roulants au vidéophone M1R0.

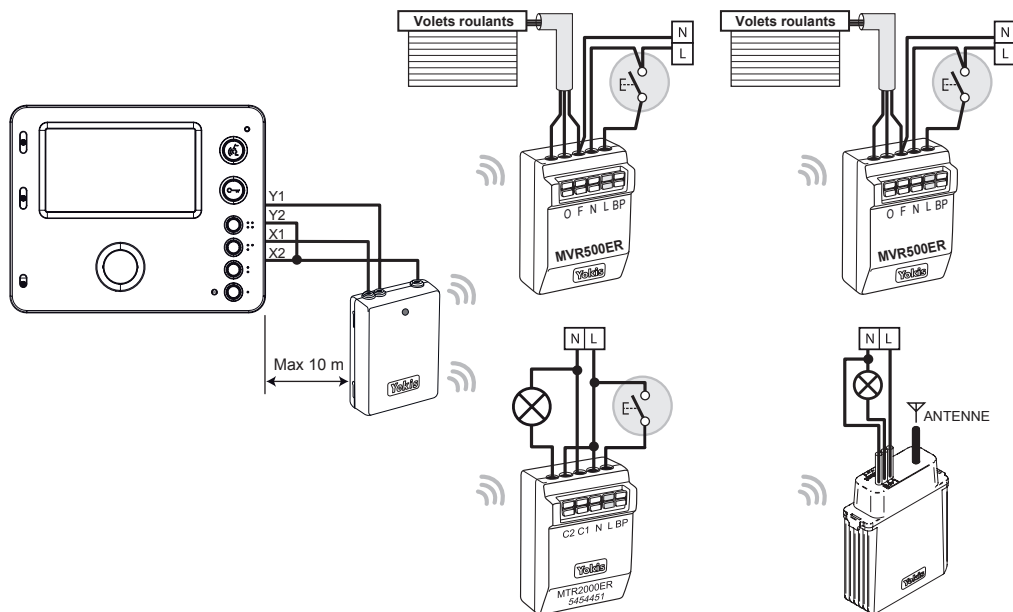

 Après avoir convenablement programmé les dispositifs Yokis, il sera possible:

- d'appuyer sur une touche (par exemple, ●●) pour activer la fermeture centralisée des volets roulants;
- d'appuyer sur une deuxième touche (par exemple, ●●●) pour activer l'extinction de l'éclairage.

Pour plus d'informations sur les produits YOKIS, visiter le site www.yokis.com.

ESPAÑOL

Los videointerfonos **miro** Ref. 1750/5 y 1750/6 están destinados al uso en instalaciones videointerfónicas del sistema 2Voice.

DESCRIPCIÓN DE LOS COMPONENTES Y CARACTERÍSTICAS

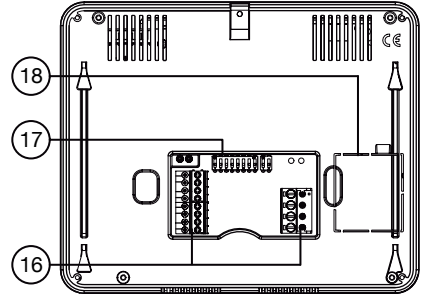
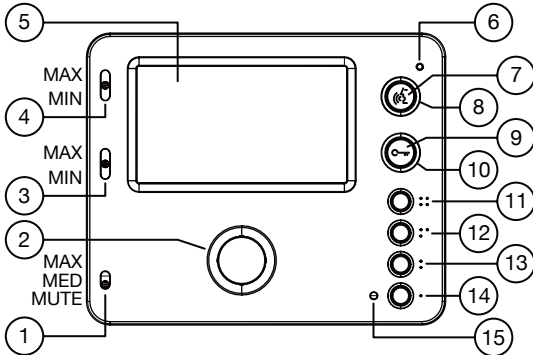

1. Regulación del volumen de llamada (MAX, MEDIO, MUTE)
2. Altavoz de llamada y conversación
3. Regulación del brillo de la pantalla
4. Regulación de la intensidad del color de la pantalla
5. Pantalla 4,3" formato 16:9
6. Micrófono
7. Pulsador activación/desactivación de la fonía
8. Led verde presente debajo del pulsador
9. Pulsador de apertura de la puerta
10. Led verde presente debajo del pulsador
11. Pulsador para la conexión a dispositivos Yokis; contactos Y1, Y2: máx. 50 mA @ 24 Vcc
12. Pulsador para la conexión a dispositivos Yokis; contactos X1, X2: máx. 50 mA @ 24 Vcc
13. Pulsador : ver la tabla de función de pulsadores
14. Pulsador : ver la tabla de función de pulsadores
15. Led de indicación multicolor
16. Bornes para la conexión al sistema
17. Interruptor dip de configuración:
 - nº 1 de SW1, define el modo de funcionamiento del videointerfono: OFF "Manos libres" (predeterminado)/ ON "Push to talk" (pulsar para hablar);
 - nº de 2 a 8 de SW1, definen el número del apartamento en la columna;
 - nº 1 y 2 de SW2, definen el número del aparato interior dentro del apartamento.

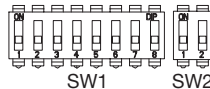

Para las configuraciones de los interruptores dip, consultar el manual de sistema.

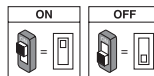

18. Tapa a retirar si se realiza una conexión entrar-salir con el accesorio Ref. 1750/50

El videointerfono **miro** tiene incorporado un dispositivo para personas con déficit auditivo, que sólo funciona durante las llamadas videointerfónicas.

INSTALACIÓN

Empotrar la caja a la altura indicada en la figura siguiente.
Fijar el soporte en la caja para empotrar o en la pared, según se indica.
Configurar los interruptores dip de programación.

Caja Mod. 503

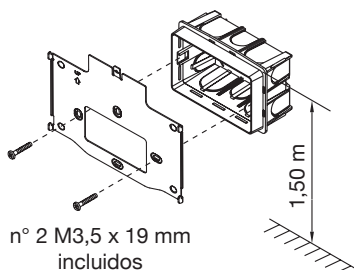

Caja Ø 60 mm

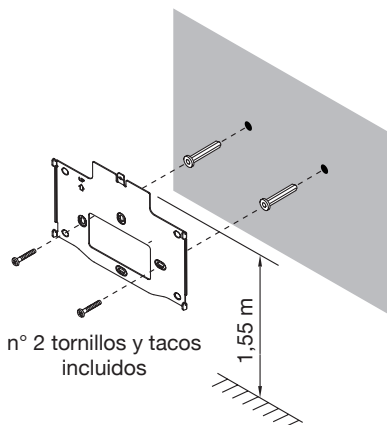
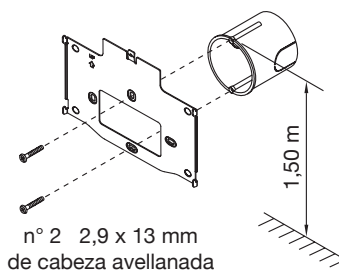

Efectuar las conexiones.
Fijar el videointerfono en el soporte.

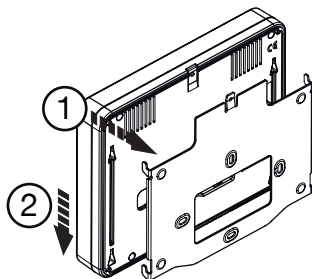

 Para retirar el videointerfono del soporte, introducir la punta de un destornillador en el alojamiento, como se indica en la figura, y empujar el videointerfono hacia arriba.

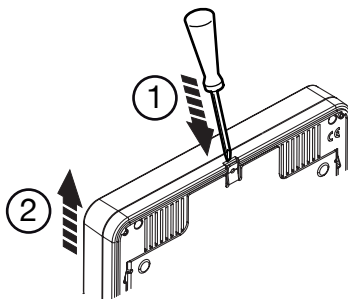

Para la conexión del videointerfono en entrar-salir se debe retirar la tapa, como se indica en la figura, e introducir en el alojamiento el circuito adaptador ref. 1750/50 siguiendo las instrucciones detalladas en el manual entregado con el producto.

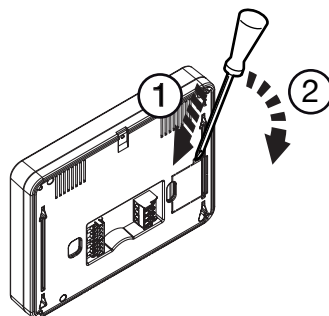

DESCRIPCIÓN DE LOS BORNES

- S+ } Timbre adicional
- S- }
- X2 } Pulsador ●●
- X1 }
- Y2 } Pulsador ●●
- Y1 }



-] CP Llamada al piso
-] LINE IN Conexión al BUS de sistema

FUNCIÓN DE LOS PULSADORES

Estado Pulsador	REPOSO	ESPERA DE RESPUESTA (RECEPCIÓN LLAMADA)	EN FONÍA	REPOSO Y PULSADOR PULSADO	ESTADO DE PROGRAMACIÓN* (SÓLO CON EL VIDEOINTERFONO EN REPOSO)
	Apertura de la puerta para peatones	Apertura de la puerta para peatones	Apertura de la puerta para peatones	Apertura de la puerta para peatones	Abilita/desabilita apropiata automatico
	---	Activación de la fonía	Si se pulsa en el modo de funcionamiento: A) "Manos libres" termina la conversación; B) en "Push to talk": — si se pulsa de modo prolongado activa la fonía hacia el microaltavoz; — si se pulsa brevemente activa o termina la conversación.	---	---
●●	Autoactivación	'Rebote vídeo'	Función especial (predeterminado: 8)	Llamada intercomunicante 2 programable (predeterminado: no programado)	Selección del timbre de llamada al piso (5 timbres distintos)
●	Apertura de la puerta del pasaje de vehículos	Apertura de la puerta del pasaje de vehículos	Apertura de la puerta del pasaje de vehículos	Llamada intercomunicante 1 programable (predeterminado: llamada a la centralita)	Selección del timbre de llamada interfónica (5 timbres distintos)

(*) Para entrar o salir del estado de programación, pulsar y mantener pulsada el pulsador ● durante más de 5 segundos; la confirmación de la entrada en programación se produce con el parpadeo lento del led amarillo; en todos los casos, cuando se cumple la temporización de 10 min. se sale del estado de programación.

INDICACIONES DE LOS LED

8. Led verde presente debajo del pulsador 
Encendido fijo: llamada en curso
encendido parpadeante: conversación en curso
10. Led verde presente debajo del pulsador 
encendido fijo: posibilidad de apertura de la puerta
15. Led de indicación multicolor

PRIORIDAD	FUNCIONES
1	Verde parpadeante: apertura automática de la puerta activada
2	Rojo encendido fijo: puerta abierta en el puesto de llamada principal
3	Rojo parpadeante lento: puerta abierta en el puesto de llamada secundario
4	Amarillo parpadeante lento: estado de programación activado

-  Para guardar la programación, recordarse de salir de la misma manteniendo pulsado el pulsador ● durante más de 5 segundos; en todos los casos, cuando se cumplen 10 minutos el dispositivo sale del estado de programación guardando los parámetros modificados.
Para la programación de la llamada intercomunicante, consultar el manual de sistema.

RESET

Para restablecer los parámetros predeterminados del dispositivo, después de entrar en programación pulsando el pulsador ● durante más de 5 segundos, pulsar simultáneamente los pulsadores ● y  durante más de 3 segundos; la confirmación del mando se produce con la emisión de 2 bips y la salida del dispositivo del estado de programación.

FUNCIONAMIENTO CON PRÓTESIS AUDITIVAS

El videointerfono cuenta con un dispositivo que permite a las personas con déficit auditivo, que llevan audifono, oír quién está hablando desde el puesto de llamada o desde otros videointerfonos en caso de llamadas de la centralita. El dispositivo está en condiciones de conectarse con los aparatos auditivos con la función "T", a una distancia de aproximadamente 20 cm.

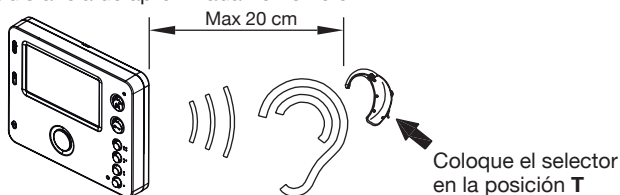

MUTE DEL ALTAVOZ DEL TIMBRE



Es posible regular el volumen de llamada hasta excluir el timbre (Mute), actuando sobre el cursor deslizante 1 (ver § Descripción de los componentes y características).

El estado mute se indica con una señal de color rojo visible en la parte superior del cursor.

-  Si el cursor está en la posición MUTE, en caso de llamada se enciende el módulo vídeo del videointerfono si la llamada es vídeo; además, se desactivan todas las indicaciones acústicas (bips). En cambio, no se desactivan los posibles timbres adicionales.

ACTIVACIÓN DE LA FONÍA PULSANDO EL PULSADOR (MODO “PUSH TO TALK”)

Si la comunicación entre el puesto de llamada y el videointerfono tiene disturbios, es posible activar los dos canales de fonía (hacia el interior y hacia el exterior) de forma individual.

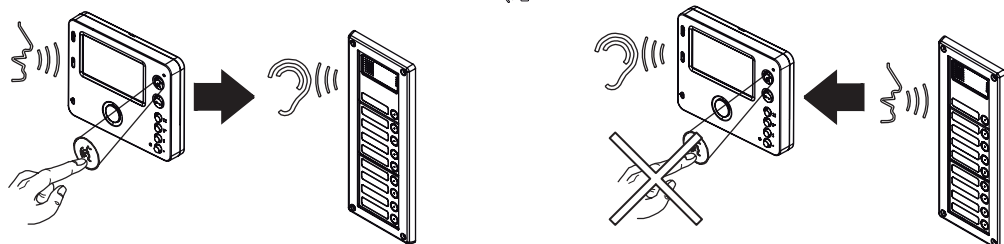

Después de recibir una llamada, pulsar brevemente para activar la fonía desde el microaltavoz; luego, si se mantiene pulsado el pulsador , se activa el canal audio hacia el exterior y se puede hablar a la persona que llama. Para escuchar se debe soltar el pulsador .

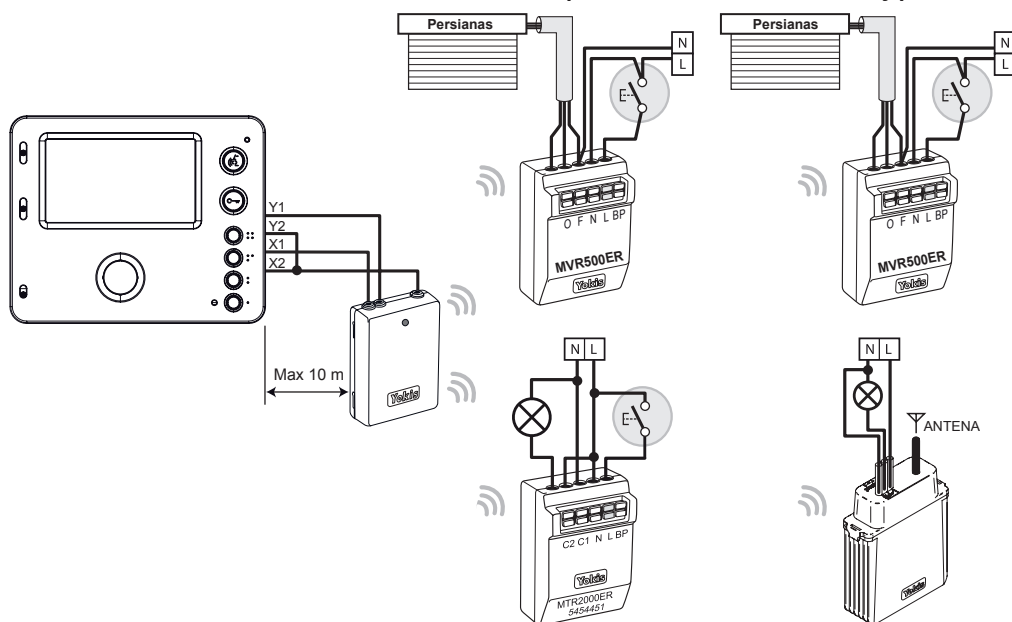

Para terminar la conversación pulsar brevemente el pulsador .

Conexión al videointerfono mïro de un módulo E2BP para la centralización de luces y persianas



-  Después de la debida programación de los dispositivos Yokis se podrá:
- con un pulsador (por ejemplo ) , activar el cierre centralizado de las persianas;
 - con un segundo pulsador (por ejemplo ) , activar el apagado de las luces.

Para mayor información sobre los productos YOKIS, visitar la página www.yokis.com

DEUTSCH

Die Videoanlagen 1750/5 e 1750/6 der Serie **miro** sind speziell für den Einsatz in 2Voice-Videoanlagen konzipiert.

GERÄTEBESCHREIBUNG UND GERÄTEMERKMALE

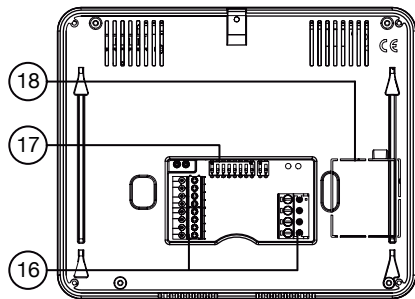
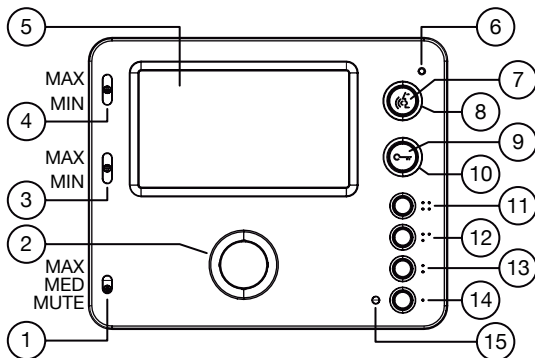

1. Einstellen der Ruftonlautstärke (STUMM - MITTEL - LAUT)
2. Gegensprech- und Ruftonlautsprecher
3. Einstellen der Display-Helligkeit
4. Einstellen der Display-Farbsättigung
5. 4,3"-Display Format 16:9
6. Mikrofon
7. Taste zur Aktivierung/Deaktivierung eines Gesprächs
8. Grüne LED unter der -Taste
9. Türöffnertaste
10. Grüne LED unter der -Taste
11. Taste : zur Anschließung an Yokis-Geräte, Kontakt Y1, Y2: max 50 mA bei 24 Vdc
12. Taste : zur Anschließung an Yokis-Geräte, Kontakt X1, X2: max 50 mA bei 24 Vdc
13. Taste : siehe Übersicht Tastenfunktion
14. Taste : siehe Übersicht Tastenfunktion
15. Mehrfarbige LED-Anzeige
16. Klemmen für den Systemanschluss
17. Konfigurationsschalter:
 - Schalter 1 SW1: legt die Betriebsart der Videoanlage fest: OFF = „Freisprechen“ (Standardeinstellung) / ON = „Push-to-Talk“
 - Schalter 2-8 SW1: legt die Nummer der Wohnung in der Steigleitung fest
 - Schalter 1-2 SW2: legt die Nummer der Innenstelle im Inneren der Wohnung fest.

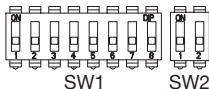

Hinsichtlich der Einstellungen des Kodierschalters siehe Systemhandbuch.

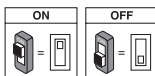

18. Deckel muss zum Durchschleifen mittels Adapterschaltung 1750/50 entfernt werden.

Die **miro**-Videoanlage verfügt über eine integrierte Einrichtung für Hörgeschädigte, die nur bei Videorufen zugeschaltet wird.

INSTALLATION

Einbaudose wie unten abgebildet in der angegebenen Höhe installieren.
Anbauplatte wie abgebildet an der Unterputzdose oder an der Wand befestigen.
Die Programmierschalter programmieren.

Einbaudosetyp 503

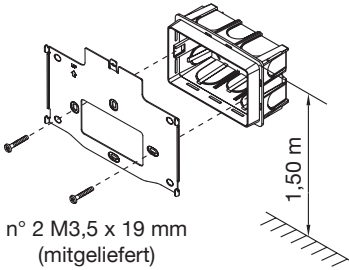

Einbaudose Ø 60 mm

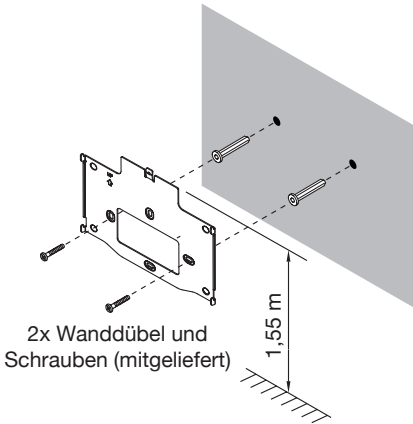
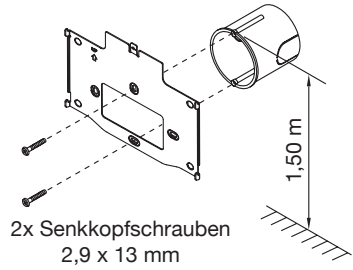

Anschlüsse herstellen.
Videoanlage an der Halterung befestigen.

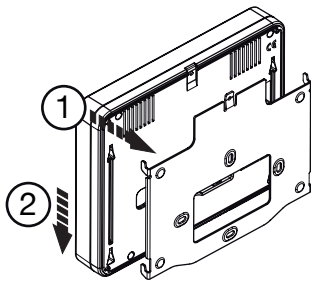

 Zum Abnehmen der Videoanlage Rastzunge mit der Spitze eines Schraubendrehers wie abgebildet abhebeln und die Videoanlage nach oben drücken.

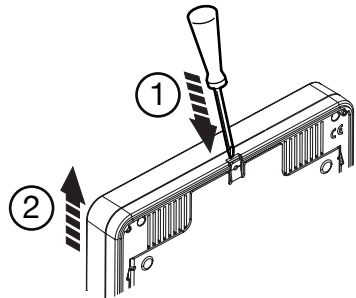

Für das Durchschleifen der Videoanlage muss der Deckel des Anschlussfachs wie abgebildet entfernt und die Adapterschaltung 1750/50 gemäß den mitgelieferten Anweisungen eingesetzt werden.

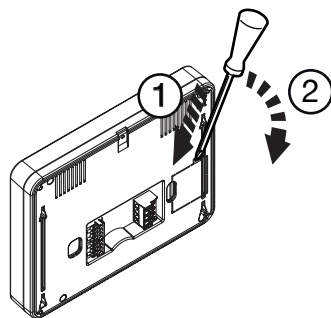

BESCHREIBUNG DER ANSCHLUSSKLEMMEN

- S+ } Zusätzliches Lätwerk
- S- } Zusätzliches Lätwerk
- X2 } Taste ●●
- X1 } Taste ●●
- Y2 } Taste ●●
- Y1 } Taste ●●



-] CP Etagenruf
-] Etagenruf
-] LINE IN Anschluss an den System-BUS
-] Anschluss an den System-BUS

TASTENFUNKTION

Status Taste	RUHESTELLUNG	WARTEZEIT ABHEBEN (RUFINGANG)	IM GESPRÄCH	RUHESTELLUNG UND TASTE  GEDRÜCKT	PROGRAMMIER- STATUS* (NUR BEI VIDEOANLAGE IN RUHESTELLUNG)
	Türöffnerbefehl	Türöffnerbefehl	Türöffnerbefehl	Türöffnerbefehl	Automatischen Türöffner ein-/ausschalten
	---	Sprechkanal freischalten	In Betriebsart A) „Freisprechen“: das Gespräch wird beendet; B) „Push-to-Talk“: — Sprechkanal nach außen freischalten mit langem Tastendruck — Gespräch beginnen oder beenden mit kurzem Tastendruck.	---	---
●●	Selbsteinschaltung	Videobildübertragung	Sonderfunktion (Standard: 8)	Programmierbarer Intercom-Anruf 2 (Standard: nicht programmiert)	Auswahl Lätwerk Etagenruf (5 verschiedene Lätwerke)
●	Türöffner der Einfahrt	Türöffner der Einfahrt	Türöffner der Einfahrt	Programmierbarer Intercom-Anruf 1 (Standard: Ruf an die Zentrale)	Auswahl Lätwerk Sprechanlagenruf (5 verschiedene Lätwerke)

(*) Um sich in den Programmierstatus zu begeben oder diesen zu verlassen, die Taste ● länger als 5 Sekunden gedrückt halten. Die Bestätigung des Beginns des Programmierstatus erfolgt durch langsames Blinken der gelben Led. In jedem Fall verlässt man nach Ablauf des Takts von 10 Minuten den Programmierstatus.

LED-ANZEIGEN

8. Grüne LED unter der -Taste
Dauerlicht: eingehender Ruf
Blinklicht: laufendes Gespräch
10. Grüne LED unter der -Taste
Dauerlicht: Türöffnung möglich
15. Mehrfarbige LED-Anzeige

PRIORITÄT	FUNZIONI
1	Grün blinkend: automatischer Türöffner aktiv
2	Rot durchgehend einschaltet: Tür auf Hauptrufstelle geöffnet
3	Rot langsam blinkend: Tür auf Nebenrufstelle geöffnet
4	Gelb langsam blinkend: Programmierstatus aktiv

 Drücken Sie zum Speichern der Programmierung mindestens 5 Sekunden lang die Taste ● . Der Programmierstatus wird jedoch in jedem Fall nach Ablauf von 10 Minuten wieder verlassen und die geänderten Parameter gespeichert.
Zur Programmierung des Intercom-Rufs siehe Systemhandbuch.

ZURÜCKSETZEN

Zur Wiederherstellung der Werkseinstellungen drücken Sie zunächst mindestens 5 Sekunden lang die Taste ● , um den Programmierstatus aufzurufen, und danach mindestens 3 Sekunden lang gleichzeitig die Tasten ● und  . Die Bestätigung des Befehls erfolgt durch Aussenden von zwei langen Pieptönen und das Verlassen des Programmierstatus von Seiten des Geräts.

BETRIEB MIT HÖRGERÄTEN

Die Videoanlage verfügt über eine Einrichtung, die es Hörgeschädigten erlaubt, die Audiosignale der Rufeinheit oder - bei Anrufen über die Zentrale - anderer Videoanlagen auf einem entsprechend ausgerüsteten Hörgerät zu empfangen. Das Gerät ist in der Lage, eine Verbindung zu Hörgeräten mit Induktionsspule (T-Spule) in einer Entfernung von ca. 20 cm aufzubauen.

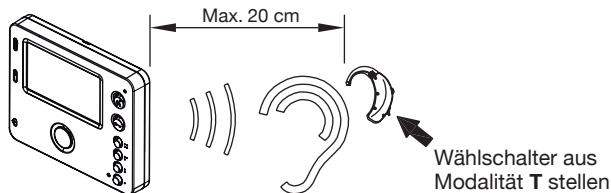

MUTE LAUTSTÄRKENEINSTELLUNG DES KLINGELTONS



Mit Schieberegler 1 kann die Rufonlautstärke eingestellt und der Ruf tonlos geschaltet werden (siehe "Gerätebeschreibung und Gerätemerkmale").

Die Mute Lautstärkeneinstellung des Klingeltons ist an einer roten Markierung im oberen Teil des Schiebereglerfensters erkennbar.

 **Bei Stummschaltung (MUTE) schaltet sich das Videomodul der Videoanlage ein, und der Ruf wird als Videoruf durchgestellt. Außerdem werden alle akustischen Signaltöne (Pieptöne) abgeschaltet. Alle ggf. vorhandenen Zusatzläutwerke bleiben weiterhin eingeschaltet.**

SPRECHEN MIT SPRECHTASTE (PUSH-TO-TALK)

Ist die Kommunikation zwischen Ruf- und Videosprechstelle gestört, können beide Sprechkanäle (nach innen und nach außen) einzeln freigeschaltet werden.

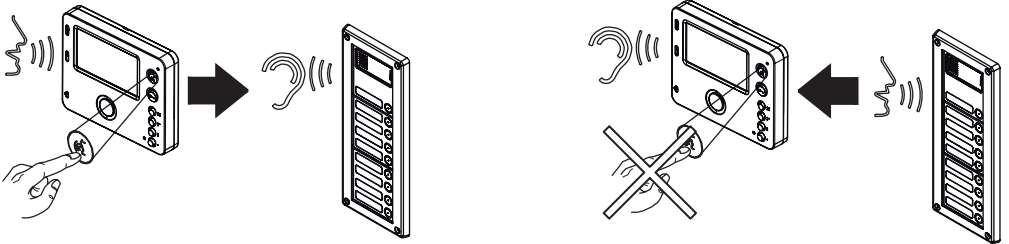

Um den Audiokanal nach außen zum Sprechen freizuschalten, drücken Sie nach der Rufannahme die Taste  und halten diese gedrückt. Zum Hören lassen Sie die Taste  wieder los.

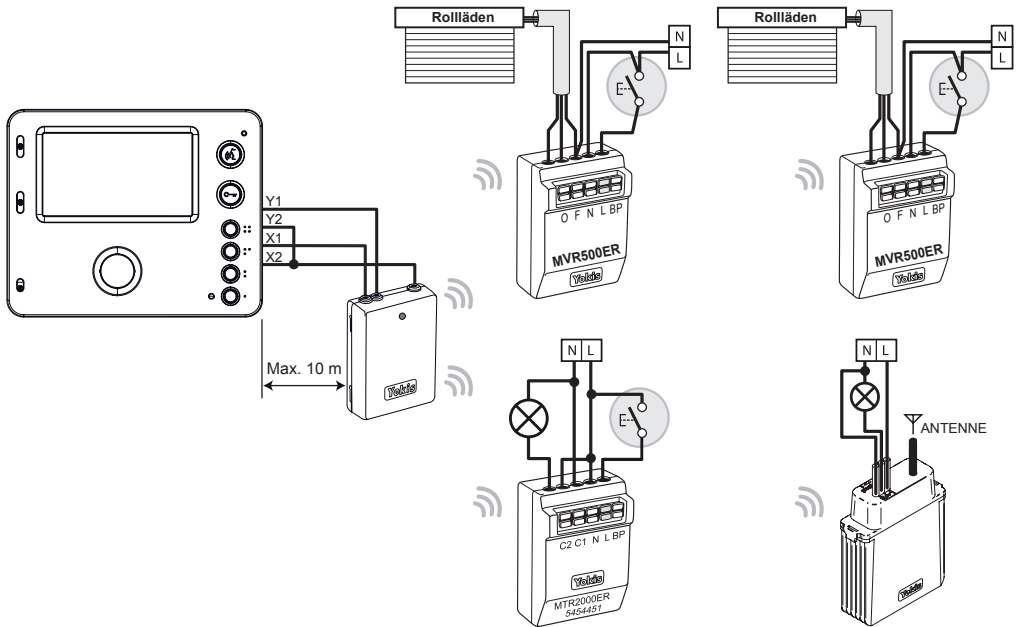

Um das Gespräch zu beenden, kurz die Taste  drücken.

Anschluss eines E2BP-Moduls an das mir0 -Videoterminal zur zentralen Beleuchtungs- und Rolllädensteuerung



-  Nach entsprechender Programmierung der Yokis-Geräte stehen folgende Möglichkeiten zur Verfügung:
- zentral gesteuertes Herunterfahren der Rollläden mit einem Taster (z. B. )
 - Ausschalten der Beleuchtung mit einem zweiten Taster (z. B. )

Weitere Informationen zur YOKIS-Produktlinie finden Sie auf www.yokis.com

DS 1750-008A

URMET S.p.A.
10154 TORINO (ITALY)
VIA BOLOGNA 188/C
Telef. +39 011.24.00.000 (RIC. AUT.)
Fax +39 011.24.00.300 - 323

urmet

LBT 20057

Area tecnica
servizio clienti +39 011.23.39.810
<http://www.urmet.com>
e-mail: info@urmet.com

Fabbricato da Urmet Electronics Limited
(azienda del gruppo Urmet) - Prodotto in Cina
Manufactured by Urmet Electronics Limited
(an Urmet group company) - Made in China